

**alberta**<sup>®</sup>  
Made in Italy



LAGUNA • NIKITA





**Black** è eleganza, fascino, forza.

Alberta sceglie un simbolo di raffinatezza e stile indiscusso per rappresentare la forza della sua nuova collezione. Linee geometriche e volumi accoglienti diventano un segno distintivo dell'azienda, sempre pronta a rinnovarsi per interpretare al meglio lo stile dell'abitazione contemporanea. Tessuti, finiture, colori sono selezionati ed accostati con cura e sapienza sartoriale, per creare prodotti unici ed esclusivi, capaci di "disegnare" lo spazio in cui sono inseriti con personalità ed un pizzico di ironia.



**Black** is elegance, fascination, strength.

Alberta chooses a symbol of undisputed sophistication and style to express the strength of the new collection. The geometric lines and enveloping shapes become a trademark for the company, always ready to innovate to better express modern living styles. Fabrics, finishes, colours are all carefully and expertly selected and matched to create unique, exclusive products that "design" the interiors with all their personality and a touch of irony.



**Black** c'est l'élégance, le charme, la force.

Alberta choisit un symbole de raffinement et de style incontesté pour représenter la force de sa nouvelle collection. Les lignes géométriques et les volumes accueillants deviennent un signe distinctif de l'entreprise, toujours prête à se renouveler pour interpréter au mieux le style de l'habitat contemporain. Les tissus, les finitions et les couleurs sont sélectionnés et associés avec soin et un savoir-faire artisanal, pour créer des produits uniques et exclusifs, en mesure de « dessiner » l'espace dans lequel ils sont intégrés avec personnalité et une pincée d'ironie.



**Black** ist Eleganz, Charme, Stärke.

Alberta entscheidet sich für ein Symbol der Eleganz und für unbestrittenen Stil, um die Stärke der neuen Kollektion zu zeigen. Die geometrischen Linien und behaglichen Formen werden so zu einem Erkennungszeichen der Firma, die jederzeit bereit ist, neue Wege einzuschlagen und den Stil modernen Wohnens gekonnt zu interpretieren. Stoffe, Oberflächen und Farben werden mit großer Sorgfalt und Schneiderkunst ausgewählt und für einzigartige und exklusive Möbel kombiniert. Möbel, die in der Lage sind, den Raum, in dem sie stehen, mit Persönlichkeit und einem kleinen Augenzwinkern zu "designen".

**alberta**

# LAGUNA



IT • Tratti distintivi del sistema di sedute Laguna sono le linee semplici e i volumi morbidi. Gli ampi cuscini e l'accogliente seduta invitano al relax esprimendosi in un design contemporaneo.

La vasta gamma di elementi, declinati in due diverse profondità, permette un'ampia modularità e consente combinazioni infinite, arredando così qualsiasi tipo di ambiente, da quelli più ampi a quelli di piccole dimensioni.

EN • The stand-out features of Laguna seating are the simple lines and soft shapes. The large cushions and roomy seat are an invitation to relax with a contemporary design.

The wide variety of elements, available in two different depths, results in a very modular design which can be combined in an endless ways. The sofa is ideal for furnishing any setting, from the biggest to the smallest.

FR • Les traits distinctifs du système d'assise Laguna sont les lignes et les volumes souples. Les amples coussins et l'accueillante assise invitent au relax, le tout exprimé en un design contemporain.

La vaste gamme d'éléments, divisée en deux différentes profondeurs, permet une ample modularité et de nombreuses combinaisons, pour meubler toutes les types de pièces, grandes ou petites.

D • Die besonderen Kennzeichen des Sitzsystems Laguna sind die klaren Linien und die weichen Volumen. Die großen Kissen und die umhüllende Sitzfläche laden zum Entspannen ein und bestechen durch ein modernes Design. Die große Auswahl an Elementen, die in zwei verschiedenen Tiefen erhältlich sind, sorgt für besondere Modularität und ermöglicht unzählige Kombinationen. So kann jede Art von Raum eingerichtet werden – von den größten Räumen bis hin zu Räumen mit kleinen Maßen.

designed and dressed by  
Alessandro Castello • Maria Antonietta Lagravinese









































# NIKITA



IT • Il divano Nikita è caratterizzato da un guscio esterno rigoroso e squadrato che racchiude una seduta morbida e accogliente. La struttura di sostegno con i piedini "a slitta" e l'originale taglio tra lo schienale e i braccioli conferiscono al divano una linea slanciata e leggera.

Il sistema di sedute comprende alcuni elementi con un taglio inclinato in pianta che permettono la creazione di composizioni inedite e innovative che si armonizzano perfettamente all'interno di ambienti contemporanei.

EN • The Nikita sofa has a solid external frame with rounded corners which supports a soft, comfy seat. The frame with a sled base and the unusual V-shaped slot between the armrest and the back give this sofa a sleek, streamlined look. The seating includes some elements with a sloping design which allows you to create new and innovative compositions which fit in perfectly with modern settings.

FR • Le canapé Nikita se caractérise par un cocon extérieur rigoureux et équilibré qui renferme une assise souple et accueillante. La structure de soutien avec les pieds luges et la coupe originale entre le dossier et les accoudoirs enrichissent le divan d'une ligne élancée et légère.

L'assise comprend certains éléments avec une coupe inclinée sur plan qui permettent la création de compositions inédites et innovantes qui s'harmonisent parfaitement avec les environnements contemporains.

D • Das Sofa Nikita zeichnet sich durch eine starre, rechteckige Hülle aus, in der sich eine weiche und umhüllende Sitzfläche verbirgt. Das Gestell mit den „schlittenförmigen“ Stellfüßen und die originelle Absetzung zwischen Rückenlehne und Armlehnen verleihen diesem Sofa eine schlanke und leichte Form.

Das Sitzsystem umfasst einige Elemente mit schräger Unterbrechung bei Draufsicht, wodurch bis dato unveröffentlichte und innovative Kombinationen entstehen, die sich perfekt in moderne Räumlichkeiten einfügen.

designed and dressed by  
Alessandro Castello • Maria Antonietta Lagravinese









































# RIEPILOGO • SUMMARY





# LAGUNA



4

5

**LAGUNA** divano/sofa/canapé/Sofa  
 • 01LAGC17 (1LAGTRSPSC+ 1LAGD3DX) • 8261 Day oasis, Cat. 8  
 • Grosgrain G44  
**CECILE** poltrona/armchair/fauteuil/Sessel  
 • 2CECPNC • 9J5 Kira terra, Cat. H • Struttura/structure/Struktur Noce Canaletto, French Bronze  
**JAGGER 75** tavolino/small table/table/Couchtisch ø75  
 • 1JAGTM • Mink Brown  
**JAGGER 35** tavolino/small table/table/Couchtisch ø35  
 • 1JAGTH • Dove Grey  
**ALBERT1 50** tavolino/small table/table/Couchtisch ø50  
 • 1AL1TROT50 • Top marmo/marble/marbre/Marmor Calacatta White, Cat. X4 • struttura/structure/Struktur Noce Canaletto  
**ISLAND** tavolino/small table/table/Couchtisch  
 • 1ISNTLTS30 • 1ISNTMTS23 • 1ISNTSTS40 • Top Noce Canaletto  
 • struttura/structure/Struktur French Bronze

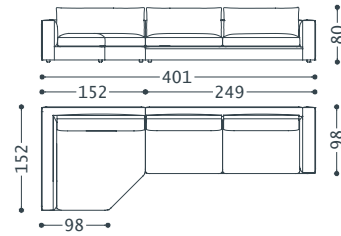

14

15

**LAGUNA** divano/sofa/canapé/Sofa  
 • 02LAGC8 (2LAGD2MSX + 2LAGDCHLMDX) • 8C8 Dakota smoke, Cat. F  
**JAMMIN LARGE** poltrona/armchair/fauteuil/Sessel  
 • 1JAMPL • 7281 Lagosta orzo, Cat. 7 • piede/foot/pied/ Fuß Gun Metal  
**FRISCO 130** tavolino/small table/table/Couchtisch 130x80  
 • 1FRITAVR • Top 1 marmo/marble/marbre/Marmor Calacatta Cream, Cat. X4 • Top 2 Mink Brown • struttura/structure/Struktur Gun Metal  
**FRISCO 50** tavolino/small table/table/Couchtisch ø50  
 • 1FRITROT • Top 1 marmo/marble/marbre/Marmor Calacatta Cream, Cat. X4 • Top 2 Mink Brown • struttura/structure/Struktur Gun Metal  
**PHIL** tavolino/small table/table/Couchtisch  
 • 1PHISER • marmo/marble/marbre/Marmor Calacatta Cream, Cat. X4 • struttura/structure/Struktur Gun Metal  
**JAGGER 35** tavolino/small table/table/Couchtisch ø35  
 • 1JAGTH • Dove Grey

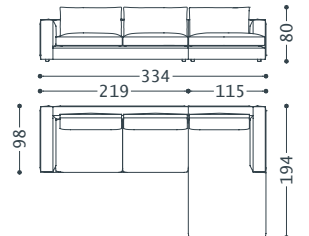

10

11

**LAGUNA** divano/sofa/canapé/Sofa  
 • 2LAGD3 • 945 Fjord Grigio antracite, Cat. G - Grosgrain G41  
**GOSSIP** poltrona/armchair/fauteuil/Sessel  
 • 1GSPP • 6046 Balboa salepepe, Cat. 6  
**ALBERT1 130** tavolino/small table/table/Couchtisch 130X80  
 • 1AL1TAVR • Top marmo/marble/marbre/Marmor Emperador Brown, Cat. X3 • struttura/structure/Struktur Noce Canaletto  
**ALBERT1 50** tavolino/small table/table/Couchtisch ø50  
 • 1AL1TROT50 • Top marmo/marble/marbre/Marmor Emperador Brown, Cat. X3 • struttura/structure/Struktur Noce Canaletto  
**JAGGER 35** tavolino/small table/table/Couchtisch ø35  
 • 1JAGTH • Dove Grey  
**JAGGER 50** tavolino/small table/table/Couchtisch ø50  
 • 1JAGTL • Dove Grey

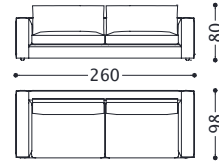

16

17

**LAGUNA** divano/sofa/canapé/Sofa  
 • 01LAGC3 (1LAGD3SX + 1LAGMERDX) • 7281 Lagosta orzo, Cat.7 - Grosgrain G41  
**EVOLUTION** poltrona relax/relax armchair/fauteuil relax/Sessel relax  
 • 2EVLPAONO • 945 Fjord Grigio antracite, Cat. G • Struttura esterna/surface/structure exterieur/Aussere Struktur Noce/Walnut/ noyer/ Nußbaum • basamento/base/piétement/Basis alluminio lucido/ glossy aluminium/aluminium poli/polierem Aluminium  
**EVOLUTION** pouff/pouf/Hocker  
 • 2EVLPOUFFAL • 945 Fjord Grigio Antracite, Cat. G • Basamento/ base/piétement/Basis alluminio lucido/glossy aluminium/aluminium poli/polierem Aluminium  
**JIMMY 3 150x190** tavolino/small table/table/Couchtisch 150x90  
 • 1J3TAVRL • Top Mink brown • struttura/structure/Struktur French Bronze  
**JIMMY 3 75x75** tavolino/small table/table/Couchtisch 75X75  
 • 1J3TAVQ75 • Top Dove Grey • struttura/structure/Struktur Gun Metal  
**JIMMY 3 55x55** tavolino/small table/table/Couchtisch 55X55  
 • 1J3TAVQ55H • Top Mink Brown • struttura/structure/Struktur French Bronze  
**JIMMY 3** tavolino/small table/table/Couchtisch  
 • 1J3SER • Top Dove Grey • struttura/structure/Struktur Gun Metal  
**MALAY** mobile porta TV/TV cabinet/meuble TV/ Fernsehschrank  
 • 1MAYMOBTV • finitura/finishing/finition/Feinbearbeitung Noce Canaletto • fascia laccata/lacquered band/bande laquee/lackiertes Band Mink Brown • maniglie-struttura/handles-structure/poignées-structure/Griffe-Struktur French Bronze

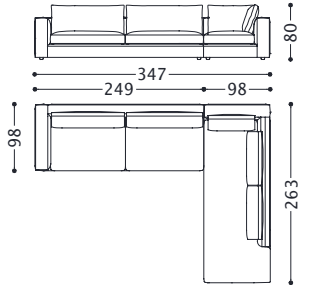

12

13

**LAGUNA** divano/sofa/canapé/Sofa  
 • 1LAGD3MPR • 6046 Balboa salepepe, Cat. 6 - Grosgrain G41  
**JAMMIN** poltrona/armchair/fauteuil/Sessel  
 • 8196 Zincy Grigio chiaro, Cat. 8 • basamento/base/piétement/Basis French Bronze  
**FRISCO 50** tavolino/small table/table/Couchtisch ø50  
 • 1FRITROT • Top 1 marmo/marble/marbre/Marmor Calacatta White, Cat. X4 • Top 2 Dove Grey • struttura/structure/Struktur French Bronze  
**ISLAND** tavolino/small table/ table/Couchtisch  
 • 1ISNTLTS30 • Top Noce Canaletto • struttura/structure/Struktur French Bronze  
**ISLAND** tavolino/small table/table/Couchtisch  
 • 1ISNTSTS40 • Top Noce Canaletto • struttura/structure/Struktur French Bronze  
**JAGGER 75** tavolino/small table/table/Couchtisch ø75  
 • 1JAGTM • Cream

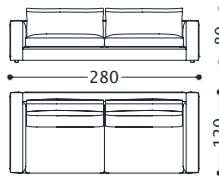

20

21

**LAGUNA** divano/sofa/canapé/Sofa  
 • 2LAGTRSPSC + 1LAGD31 + 2LAGPFFQ + 1LAGD3DX  
 • 1LAGD31 - 1LAGD3DX 7635 Dolm col.27, Cat. 7; 2LAGTRSPSC - 2LAGPFFQ 945 Fjord Grigio Antracite Cat. G - Grosgrain G57  
**GOSSIP** poltrona/armchair/fauteuil/Sessel  
 • 1GSPP • 7292 Rhodes petrolio, Cat. 7  
**FRISCO 120X120** tavolino/small table/table/Couchtisch 120X120  
 • 1FRITAVQB • Top 1 marmo/marble/marbre/Marmor Calacatta White, Cat. X4 • Top 2 Dove Grey • struttura/structure/Struktur French Bronze  
**PHIL** tavolino/small table/table/Couchtisch  
 • 1PHISER • marmo/marble/marbre/Marmor Verde Issorie, Cat. X4  
 • struttura/structure/Struktur French Bronze

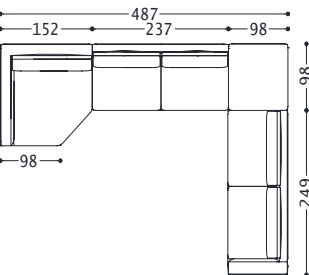

# NIKITA



24

25

- NIKITA** divano/sofa/canapé/Sofa  
 • 2NKTD3 • 945 Fjord Grigio antracite, Cat. G • piede/foot/pied/ Fuß Gun Metal  
**JAMMIN** poltrona/armchair/fauteuil/Sessel  
 • 2JAMP • 945 Fjord Grigio antracite, Cat. G • piede/foot/pied/ Fuß Gun Metal  
**JAMMIN** pouff/pouf/Hocker  
 • 1JAMPOUFF • 8177 Zincy pino, Cat. 8 • piede/foot/pied/ Fuß Gun Metal  
**FRISCO 130x80** tavolino/small table/table/Couchtisch 130x80  
 • 1FRITAVR • Top 1 marmo/marble/marbre/Marmor Calacatta White, Cat. X4 • Top 2 Mink Brown • struttura/structure/Struktur Gun Metal  
**FRISCO 75x75** tavolino/small table/table/Couchtisch 75x75  
 • 1FRITAVQA • Top 1 marmo/marble/marbre/Marmor Calacatta White, Cat. X4 • Top 2 Mink Brown • struttura/structure/Struktur Gun Metal  
**FRISCO 50** tavolino/small table/table/Couchtisch ø50  
 • 1FRITROT • Top 1 marmo/marble/marbre/Marmor Verde Issorie, Cat. X4 • Top 2 Mink Brown • struttura/structure/Struktur Gun Metal  
**JAGGER 35** tavolino/small table/table/Couchtisch ø35  
 • 1JAGTH • Mink Brown

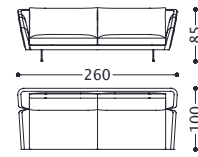

32

33

- NIKITA** divano/sofa/canapé/Sofa  
 • 01NKTC6 (1NKTAGSX + 1NKTR2MDX) • 7378 Asse Col.30, Cat. 7 - Grosgrain G57 • piede/foot/pied/ Fuß French Bronze  
**GOSSIP** poltrona/armchair/fauteuil/Sessel  
 • 1GSPP • 6047 Balboa malachite, Cat. 6  
**JIMMY 3 150x90** tavolino/small table/table/Couchtisch 150x90  
 • 1JI3TAVRL • Top Dove Grey • struttura/structure/Struktur French Bronze  
**JIMMY 3** tavolino/small table/table/Couchtisch  
 • 1JI3SER • Top Dove Grey • struttura/structure/Struktur French Bronze  
**JAGGER 75** tavolino/small table/table/Couchtisch ø75  
 • 1JAGTM • Dove Grey  
**JAGGER 35** tavolino/small table/table/Couchtisch ø35  
 • 1JAGTH • Dove Grey

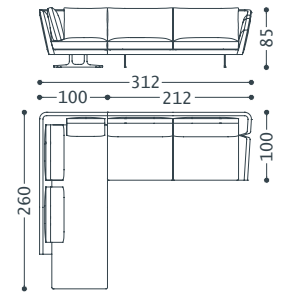

26

27

- NIKITA** divano/sofa/canapé/Sofa  
 • 1NKTD3SP • 8197 Zincy Grigio medio, Cat. 8- Grosgrain G51 • piede/foot/pied/ Fuß Gun Metal  
**SENATOR** poltrona relax/armchair relax/fauteuil relax/Sessel relax  
 • 2SENPAQSG • 945 Fjord Grigio antracite, Cat. G • basamento/base/piétement/Basis cromo nero/ black chrome/chromé noir/ Chromschwarz  
**SENATOR** pouff/pouf/Hocker  
 • 2SENPOUFF • 945 Fjord Grigio antracite, Cat. G • basamento/base/piétement/Basis cromo nero/ black chrome/chromé noir/ Chromschwarz  
**ISLAND** tavolino/small table/table/Couchtisch  
 • 1ISNTLTS30 • Top Noce Canaletto • struttura/structure/Struktur Gun Metal  
**ISLAND** tavolino/small table/table/Couchtisch  
 • 1ISNTSTS40 • Top Noce Canaletto • struttura/structure/Struktur Gun Metal  
**JIMMY 3 55x55** tavolino/small table/table/Couchtisch 55x55  
 • 1JI3TAVQ55H • Top Mink Brown • struttura/structure/Struktur Gun Metal  
**JAGGER 35** tavolino/small table/table/Couchtisch ø35  
 • 1JAGTH • Burgundy

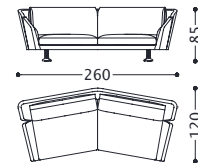

34

35

- NIKITA** divano/sofa/canapé/Sofa  
 • 01NKTC1 (1NKTMERSX + 1NKTRDX) • 6139 Cavour Platino, Cat. 6 - Grosgrain G41 • piede/foot/pied/ Fuß Gun Metal  
**CECILE** poltrona/armchair/fauteuil/Sessel  
 • 1CECPNC • 6581 Plain 8750/111 scacco, Cat. 6 • Struttura/structure/Struktur Noce Canaletto, French Bronze  
**ISLAND** tavolino/small table/table/Couchtisch  
 • 1ISNTLTS30 • 1ISNTMTS23 • 1ISNTSTS40 • Top Noce Canaletto • struttura/structure/Struktur Gun Metal  
**JIMMY 3 55x55** tavolino/small table/table/Couchtisch 55x55  
 • 1JI3TAVQ55H • Top Dove Grey • struttura/structure/Struktur Gun Metal  
**JIMMY 3** tavolino/small table/table/Couchtisch  
 • 1JI3SER • Top Dove Grey • struttura/structure/Struktur Gun Metal  
**ALBERT1 50** tavolino/small table/table/Couchtisch ø50  
 • 1AL1TROT50 • Top marmo/marble/marbre/Marmor Calacatta White, Cat. X4 • struttura/structure/Struktur Noce Canaletto

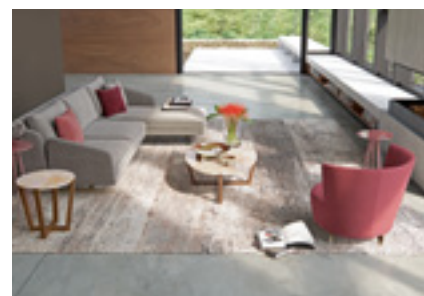
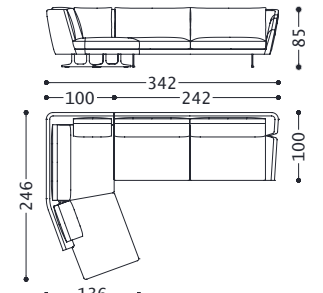

30

31

- NIKITA** divano/sofa/canapé/Sofa  
 • 01NKTC2 (1NKTR2MSX + 1NKCHLDX) • 6125 Tara Grigio chiaro, Cat. 6 - Grosgrain G41 • piede/foot/pied/ Fuß French Bronze  
**JAMMIN LARGE** poltrona/armchair/fauteuil/Sessel  
 • 1JAMPL • 6091 Velvet cherry, Cat. 6 • piede/foot/pied/ Fuß French Bronze  
**ALBERT1 130x80** tavolino/small table/table/Couchtisch 130x80  
 • 1AL1TAVOV • Top marmo/marble/marbre/Marmor Arabesque Purple, Cat. X1 • struttura/structure/Struktur Noce Canaletto  
**ALBERT1 50** tavolino/small table/table/Couchtisch ø50  
 • 1AL1TROT50 • Top marmo/marble/marbre/Marmor Arabesque Purple, Cat. X1 • struttura/structure/Struktur Noce Canaletto  
**JAGGER 35** tavolino/small table/table/Couchtisch ø35  
 • 1JAGTH • Burgundy

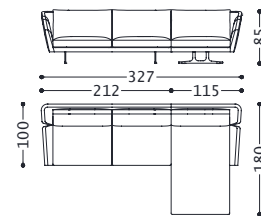



# FINITURE • FINISHING





# MARMO/MARBLE/MARBRE/MARMOR

---



Magic Brown • Cat. X1



Arabesque purple • Cat. X1



Daino Reale • Cat. X2



Cream Calacatta • Cat. X4



Verde Issorie • Cat. X4



Marquina black • Cat. X2

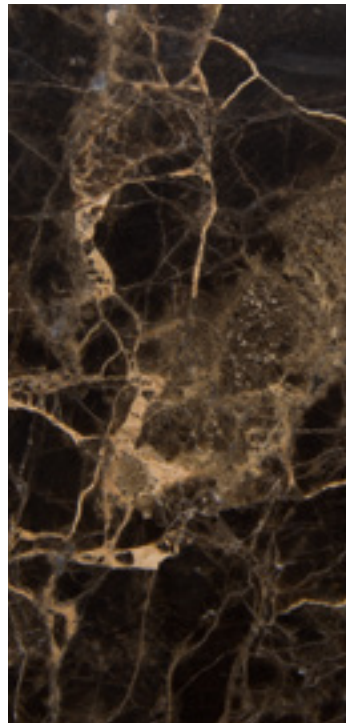

Emperador Brown • Cat. X3

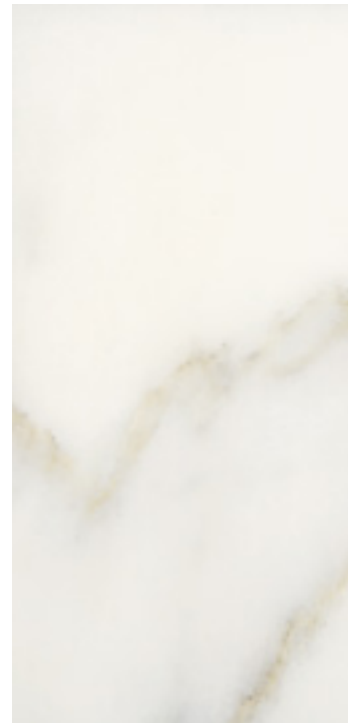

Calacatta White • Cat. X4



## METALLO/METAL/MÉTAL/METALL

---

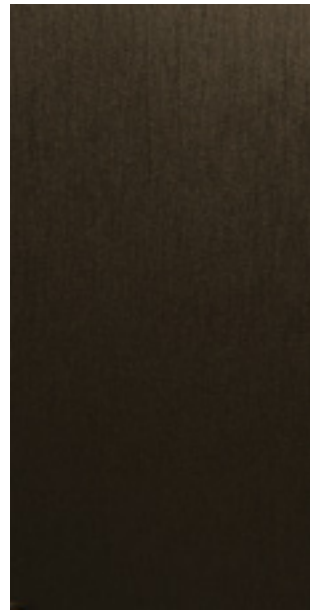

Gun Metal

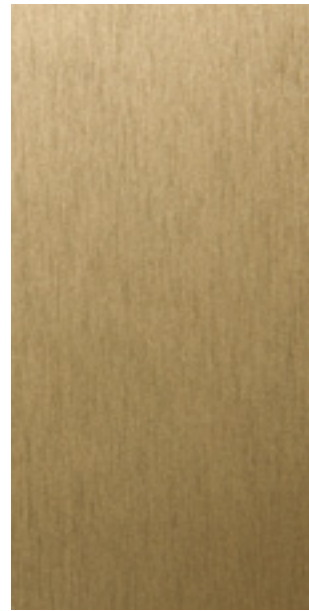

French Bronze

## LEGNO/WOOD/BOIS/HOLZ

---

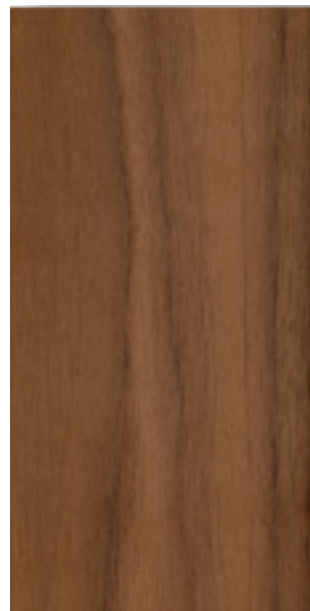

Noce Canaletto / Canaletto Walnut



Rovere Scuro / Dark Oak

## LACCATI/LACQUERED/LAQUÉS/LACKIERT

---

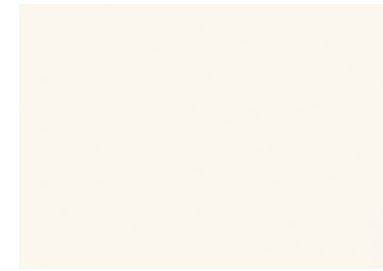

Ivory

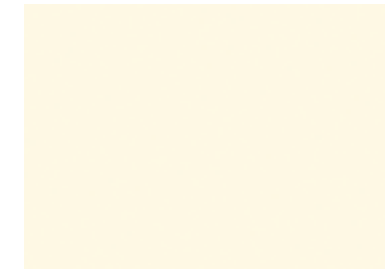

Cream



Mist



Grey



Dove Grey



Mink Brown

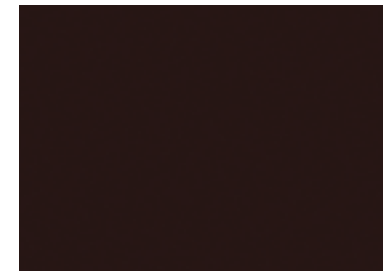

Dark brown

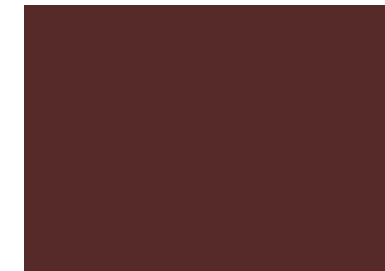

Bordeaux



Rust



Green



Blue

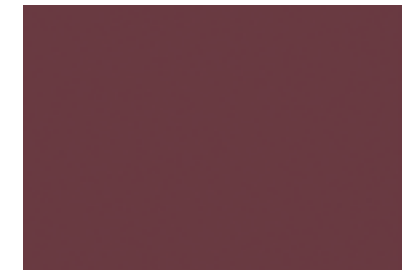

Burgundy



**DATI TECNICI**  
**TECHNICAL DATA**





**LAGUNA** divano/sofa/canapé/Sofa  
 elementi/elements/éléments/Elemente

designed by Castello Lagravinese Studio



**Struttura portante:** Multistrato, massello di legno.  
**Imbottiture:** Cuscino di schienale in piuma d'oca e fibra di poliestere con inserto in poliuretano espanso (densità 21 kg/mc) rivestito in tela di cotone. Secondo cuscino di schienale (elementi profondi) in piuma d'oca e fibra di poliestere rivestito in tela di cotone/poliestere. Cuscino di seduta in piuma d'oca e fibra di poliestere con inserto in poliuretano espanso a densità differenziata, rivestito in tela di cotone/poliestere. Scocca in poliuretano espanso a densità differenziata rivestita in resinato accoppiato a vellutino.  
**Molle:** Cinghie elastiche in polipropilene e gomma.  
**Piedino:** ABS, h. 4 cm.

**Main structure:** Solid wood.  
**Upholstery:** Backrest in goose feathers and polyester fiber with internal padding in polyurethane foam (density 21 kg/mc) covered with cotton fabric. Second backrest cushion (deep elements) in goose feathers and polyester fiber covered with cotton fabric/polyester. Seat cushion in goose feathers and polyester fiber with internal padding in polyurethane foam with different densities, covered with cotton fabric/polyester. Chassis in polyurethane foam with different densities covered with resinated coupled with velvet.  
**Suspensions:** Elastic belts in polypropylene and rubber.  
**Feet:** ABS, h. 4 cms.

**Structure:** Multiplis, bois massif.  
**Rembourrage:** Coussins de dossier en plumes d'oie et fibre de polyester avec insert en mousse de polyuréthane (densité 21 Kg/mc) sous housse de coton. Deuxième coussin de dossier (éléments profonds) en plumes d'oie et fibre de polyester sous housse de coton/polyester. Coussin d'assise en plumes d'oie et fibre de polyester avec insert en mousse de polyuréthane à densités différentes, sous housse de coton/polyester. Chassis en mousse de polyuréthane à densités différentes revêtue de résine accouplée avec velveteen.  
**Suspension:** Sangles élastiques en polypropylène et mousse.  
**Pieds:** ABS, h. 4 cm.

**Hauptstruktur:** vielschichtiges Massivholz.  
**Polsterung:** Rückenissen aus Gänsedaunen und Polyesterfaser mit Einsatz aus Polyurethanschaum (Dichte 21 Kg/mc) mit Baumwolle bedeckt. Zweiter Rückenissen (tiefe Elemente) aus Gänsedaunen und Polyesterfaser mit Einsatz aus Polyurethanschaum in unterschiedlichen Dichten und mit Baumwolle-Polyesterstoffe bedeckt. Chassis aus Polyurethanschaum mit unterschiedlicher Dichte mit gekoppeltem Samt und Resinat verkleidet.  
**Federung:** Elastische Gurte aus Gummi und Polypropylen.  
**Füße:** ABS, h. 4 cm.

Cod. Tessuto/fabric/tissu/Stoff: 1/01  
 Cod. Pelle/leather/cuir/Leder: 2/02

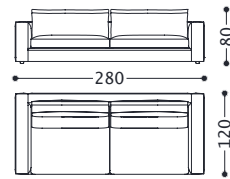
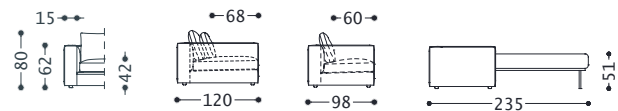

1LAGD3MPR  
 2LAGD3MPR

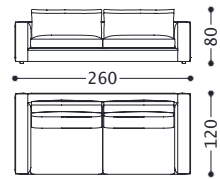

1LAGD3PR  
 2LAGD3PR

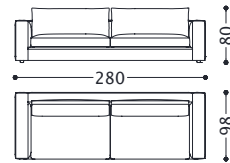

1LAGD3M  
 2LAGD3M

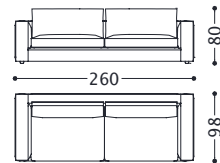

1LAGD3  
 2LAGD3

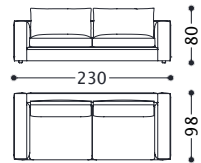

1LAGD2M  
 2LAGD2M

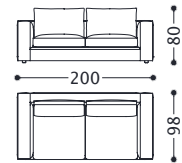

1LAGD2  
 2LAGD2

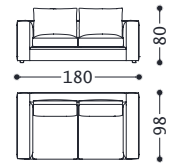

1LAGD2S  
 2LAGD2S

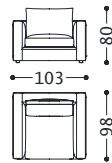

1LAGP  
 2LAGP

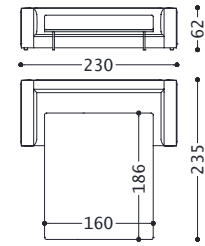

1LAGD2MSPP  
 2LAGD2MSPP

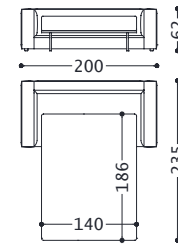

1LAGD2SPP  
 2LAGD2SPP

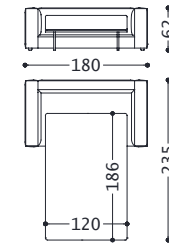

1LAGD2SSPP  
 2LAGD2SSPP

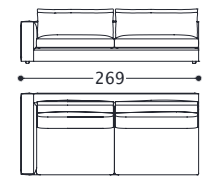

1LAGD3MPRSX  
 2LAGD3MPRSX

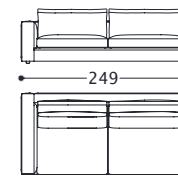

1LAGD3PRSX  
 2LAGD3PRSX

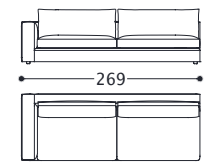

1LAGD3MSX  
 2LAGD3MSX

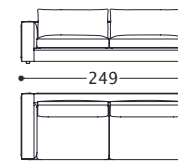

1LAGD3SX  
 2LAGD3SX

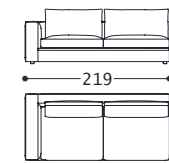

1LAGD2MSX  
 2LAGD2MSX

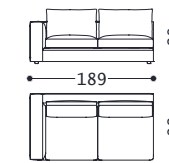

1LAGD2SX  
 2LAGD2SX

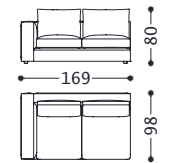

1LAGD2SSX  
 2LAGD2SSX

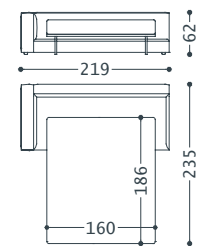

1LAGD2MSXSPP  
 2LAGD2MSXSPP

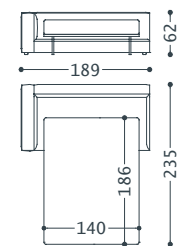

1LAGD2XSPP  
 1LAGD2XSPP

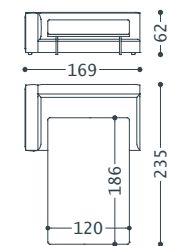

1LAGD2SSXSPP  
 2LAGD2SSXSPP

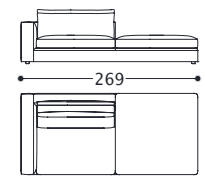

1LAGTR3MPRSX  
 2LAGTR3MPRSX

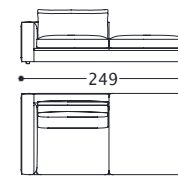

1LAGTR3PRSX  
 2LAGTR3PRSX

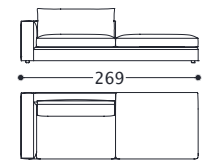

1LAGTR3MSX  
 2LAGTR3MSX

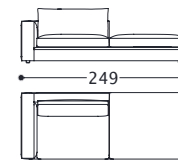

1LAGTR3SX  
 2LAGTR3SX

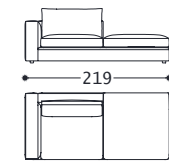

1LAGTR2MSX  
 2LAGTR2MSX

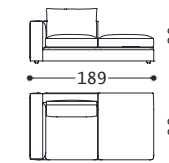

1LAGTR2SX  
 2LAGTR2SX

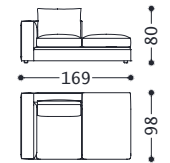

1LAGTR2SSX  
 2LAGTR2SSX







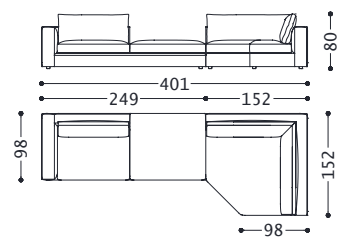

01LAGC1  
 (1LAGTR3SX + 1LAGTRSP)  
 02LAGC1  
 (2LAGTR3SX + 2LAGTRSP)

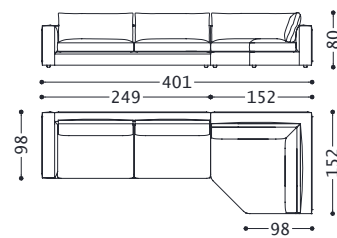

01LAGC10  
 (1LAGD3SX + 1LAGTRSP)  
 02LAGC10  
 (2LAGD3SX + 2LAGTRSP)

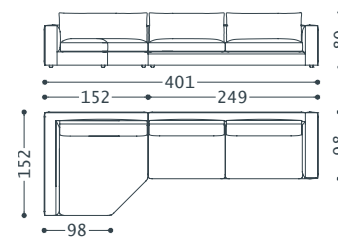

01LAGC17  
 (1LAGTRSPSC + 1LAGD3DX)  
 02LAGC17  
 (2LAGTRSPSC + 2LAGD3DX)

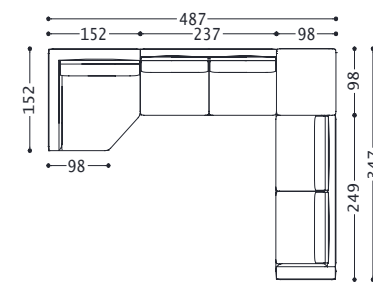

01LAGC18  
 (1LAGTRSPSC + 1LAGD31 + 1LAGPFFQ + 1LAGD3DX)  
 02LAGC18  
 (2LAGTRSPSC + 21LAGD31 + 2LAGPFFQ + 2LAGD3DX)

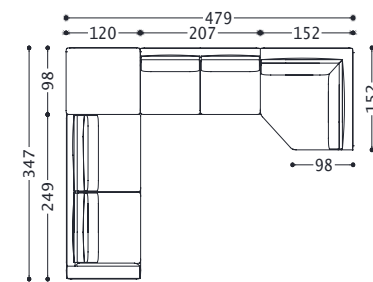

01LAGC14  
 (1LAGD3PRSX + 1LAGPFFR + 1LAGD2M1 + 1LAGTRSP)  
 02LAGC14  
 (2LAGD3PRSX + 2LAGPFFR + 2LAGD2M1 + LAGTRSP)

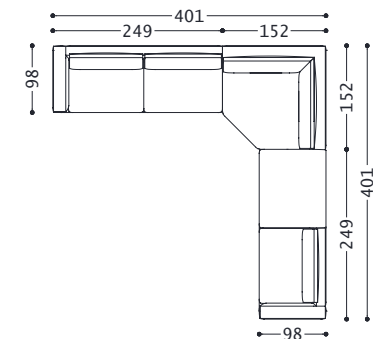

01LAGC6  
 (1LAGD3SX + 1LAGTRSP + 1LAGTR3DX)  
 02LAGC6  
 (2LAGD3SX + 2LAGTRSP + 2LAGTR3DX)

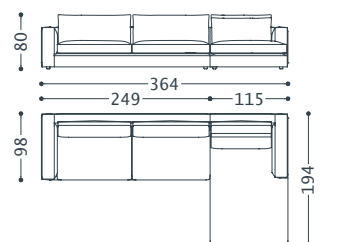

01LAGC2  
 (1LAGD3SX + 1LAGCHLMDX)  
 02LAGC2  
 (2LAGD3SX + 2LAGCHLMDX)

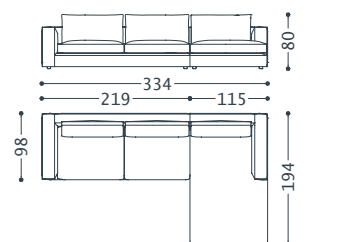

01LAGC8  
 (1LAGD2MSX + 1LAGCHLMDX)  
 02LAGC8  
 (2LAGD2MSX + 2LAGCHLMDX)

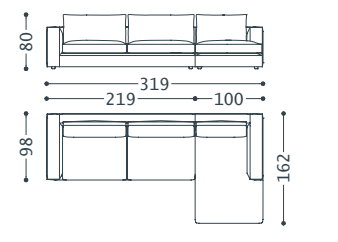

01LAGC4  
 (1LAGD2MSX + 1LAGCHLDX)  
 02LAGC4  
 (2LAGD2MSX + 2LAGCHLDX)

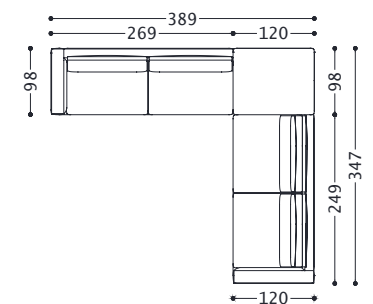

01LAGC5  
 (1LAGD3MSX + 1LAGPFFR + 1LAGD3PRDX)  
 02LAGC5  
 (2LAGD3MSX + 2LAGPFFR + 2LAGD3PRDX)

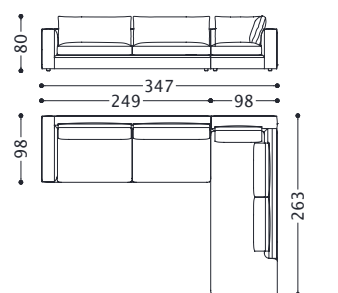

01LAGC3  
 (1LAGD3SX + 1LAGMERDX)  
 02LAGC3  
 (2LAGD3SX + 2LAGMERDX)

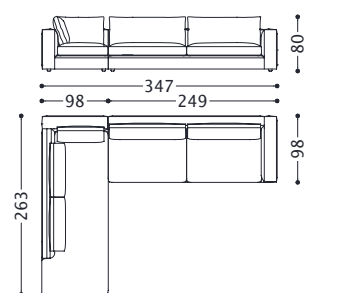

01LAGC9  
 (1LAGMERSX + 1LAGD3DX)  
 02LAGC9  
 (2LAGMERSX + 2LAGD3DX)

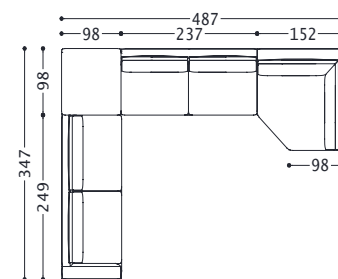

01LAGC11  
 (1LAGD3SX + 1LAGPFFQ + 1LAGD31 + 1LAGTRSP)  
 02LAGC11  
 (2LAGD3SX + 2LAGPFFQ + 2LAGD31 + 2LAGTRSP)



**NIKITA** divano/sofa/canapé/Sofa  
elementi/elements/éléments/Elemente

designed by Castello Lagravinese Studio



**Struttura portante:** Multistrato, legno massello.  
**Imbottiture:** Schienale in piuma d'oca con inserto in poliuretano espanso (densità 30 kg/mc) rivestito in tela cotone/poliestere. Seduta in piuma d'oca con inserto in poliuretano espanso (densità 35 kg/mc) rivestito in tela di cotone/poliestere. Scocca in poliuretano espanso a densità differenziata rivestito in resinato accoppiato a vellutino.  
**Molleggio:** Cinghie elastiche in polipropilene e gomma.  
**Piedino:** Staffa metallica, h. 19 cm.

**Main structure:** Solid wood.  
**Upholstery:** Backrest in goose feathers with internal padding in polyurethane foam (density 30 kg/mc) covered with cotton fabric/polyester. Seat in goose feathers with internal padding in polyurethane foam (density 35 kg/mc) covered with cotton fabric/polyester. Chassis in polyurethane foam with different densities covered with resinate coupled with velvet.  
**Suspensions:** Elastic belts in polypropylen and rubber.  
**Feet:** Metal stirrup, h, 19 cms

**Structure:** Multiplis, bois massif.  
**Rembourrage:** Coussin de dossier en plumes d'oie avec insert en mousse de polyuréthane (densité 30 Kg/mc) sous housse de coton/polyester. Coussin d'assise en plumes d'oie avec insert en mousse de polyuréthane (densité 35 Kg/mc) sous housse de coton/polyester. Chassis en mousse de polyuréthane à densités différentes revêtue de résine accouplé avec velveteen.  
**Suspension:** Sangles élastiques en polypropylène et mousse.  
**Pieds:** Etrier en métal, h. 19 cm.

**Hauptstruktur:** Vielschichtiges Massivholz.  
**Polsterung:** Rückenissen aus Gänsedaunen mit Einsatz aus Polyurethanschaum (Dichte 30 Kg/mc) mit Baumwolle-Polyesterstoffe bedeckt. Sitzkissen aus Gänsedaunen mit Einsatz aus Polyurethanschaum (Dichte 35 Kg/mc) mit Baumwolle-Polyesterstoffe bedeckt. Chassis aus Polyurethanschaum mit unterschiedlicher Dichte mit gekoppeltem Samt und Resinat verkleidet.  
**Federung:** Elastische Gurte aus Gummi und Polypropylen.  
**FüÙe:** Metallbügel, h.19 cm.

Cod. Tessuto/fabric/tissu/Stoff: 1/01  
Cod. Pelle/leather/ cuir/Leder: 2/02

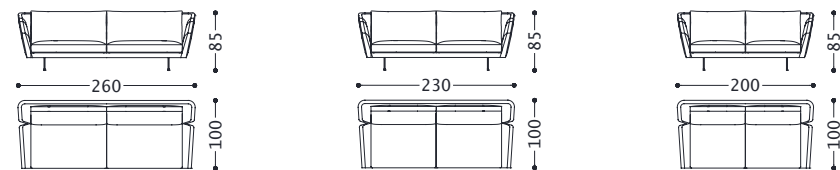
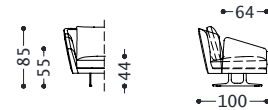

1NKTD3  
2NKTD3  
1NKTD2M  
2NKTD2M  
1NKTD2  
2NKTD2

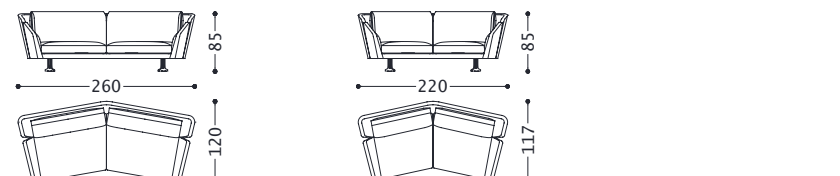

1NKTD3SP  
2NKTD3SP  
1NKTD2SP  
2NKTD2SP

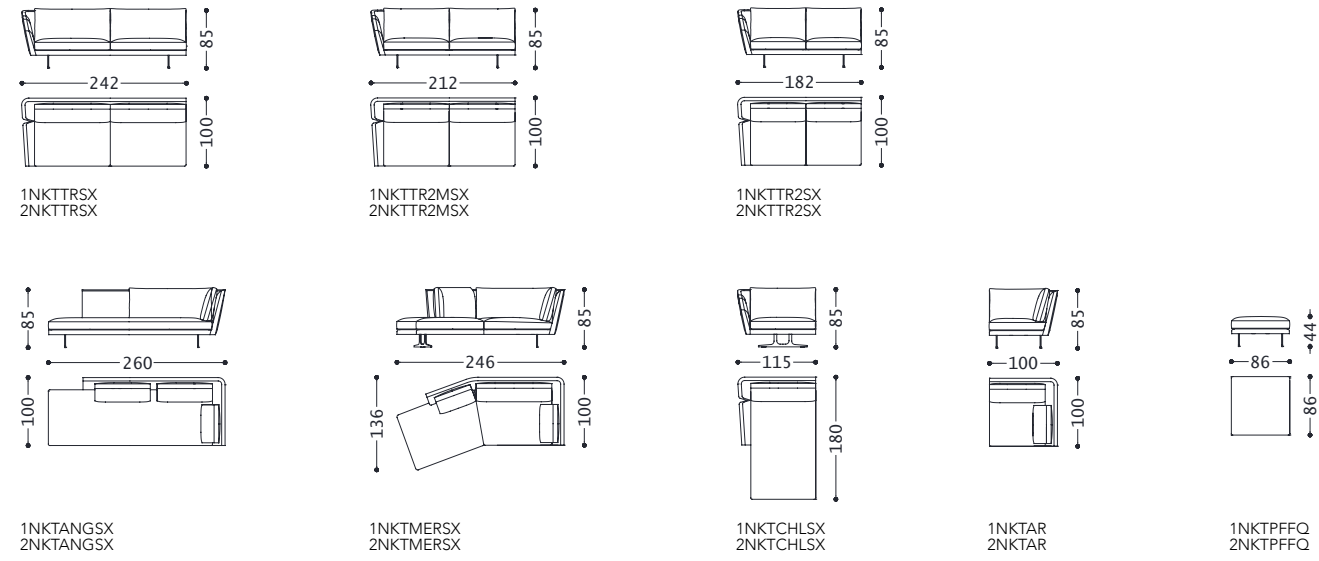

**NIKITA** divano/sofa/canapé/Sofa  
composizioni/compositions/Kompositionen

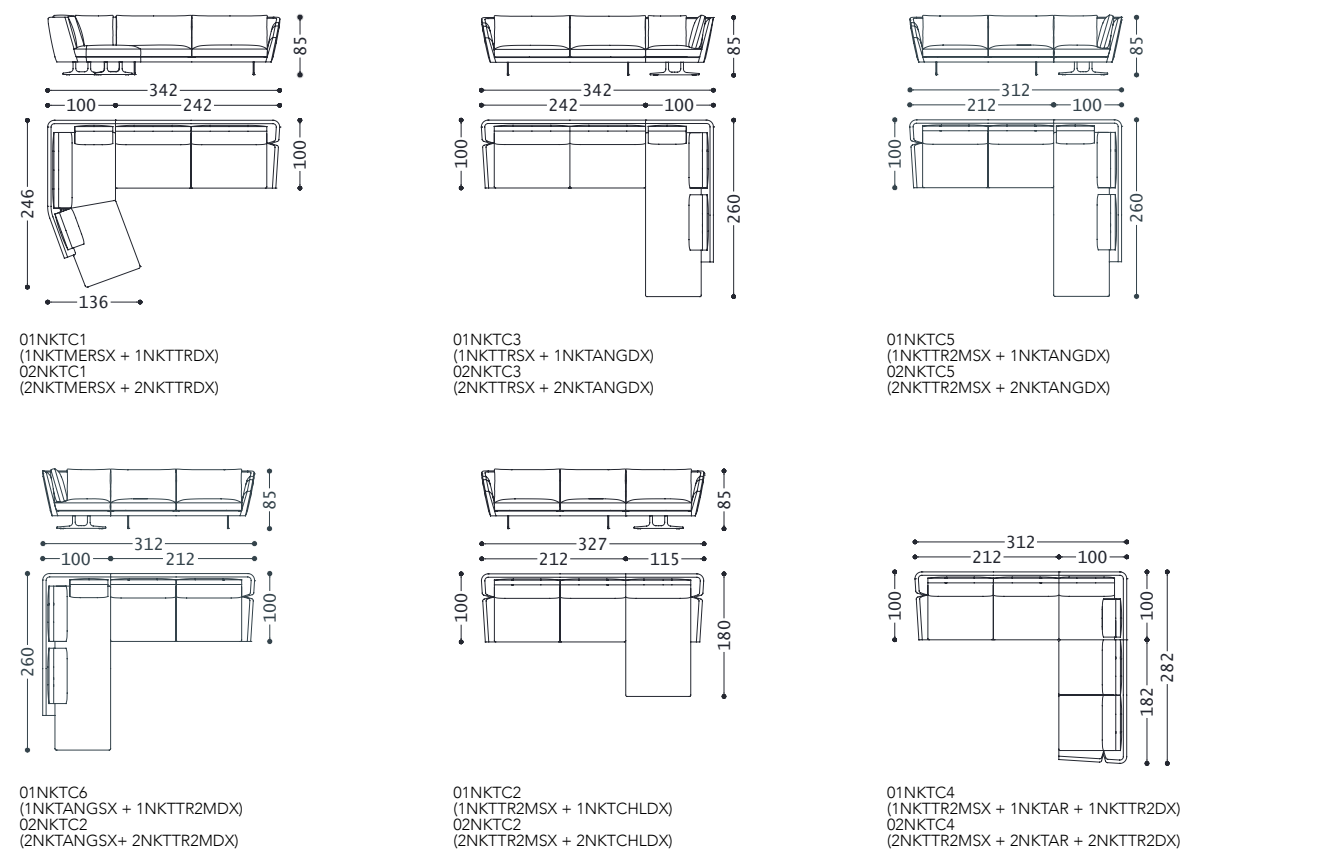



## GOSSIP poltrona/armchair/fauteuil/Sessel

elementi/elements/éléments/Elemente

designed by Castello Lagravinese Studio



**Struttura portante:** multistrato, massello di legno.  
**Imbottiture:** Schienale e seduta in poliuretano espanso (densità 40 Kg/mc).  
**Molle:** cinghie elastiche in polipropilene e gomma.  
**Piedino:** in ABS.

**Main structure:** solid wood.  
**Upholstery:** Backrest and seat in polyurethane foam (density 40 Kg/mc).  
**Suspensions:** elastic belts in polypropylen and rubber.  
**Feet:** in ABS.

**Structure:** Multiplis et bois massif.  
**Rembourrage:** Dossier et assise en mousse de polyuréthane (densité 40 kg/mc).  
**Suspension:** sangles élastiques en polypropylène et mousse.  
**Pied:** en ABS.

**Struktur:** vielschichtiges Massivholz.  
**Polsterung:** Rückenlehne und Sitz aus Polyurethanschaum (Dichte 40 Kg/mc).  
**Federung:** elastische Gurte aus Gummi und Polypropylen.  
**Füße:** ABS.

Cod. Tessuto/fabric/tissu/Stoff: 1  
Cod. Pelle/leather/cuir/Leder: 2

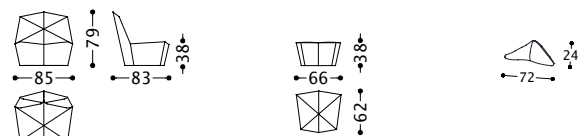

1GSPP  
2GSPP

1GSPPUUFF  
2GSPPUUFF

1GSPCF72  
2GSPCF72

## CECILE poltrona/armchair/fauteuil/Sessel

elementi/elements/éléments/Elemente

designed by Studio Memo Firenze



**Struttura cuscini:** Multistrato, massello di legno.  
**Struttura portante:** Legno/Metallo

**Opzioni finitura struttura portante** Legno: noce canaletto-wengè /Metallo: french bronze-gun metal-oro opaco.  
**Imbottiture:** Cuscino di schienale in piuma d'oca e fibra di poliestere con inserto in poliuretano espanso (densità 25 kg/mc) rivestito in tela di cotone. Cuscino di seduta in poliuretano espanso (densità 35 kg/mc), piuma d'oca e fibra di poliestere rivestito in tela di cotone.  
**Molle:** Cinghie elastiche in polipropilene e gomma.

**Cushion structure:** Solid wood.

**Main structure:** Wood/Metal

**Finishing options main structure** Wood: noce canaletto-wengè/Metal: french bronze- gun metal- matt gold.

**Upholstery:** Backrest in goose feathers and polyester fiber with internal padding in polyurethane foam (density 25 kg/mc) covered with cotton fabric. Seat cushion in polyurethane foam (density 35 kg/mc), goose feathers and polyester fiber, covered with cotton fabric.

**Suspensions:** Elastic belts in polypropylen and rubber.

**Structure de coussins:** Multiplis et bois massif.

**Structure:** Bois/ Métal

**Versions des finitions de la structure** Bois: noce canaletto-wengè/ Métal: french bronze- gun metal- or mat.

**Rembourrage:** Coussin de dossier en plumes d'oie et fibre de polyester sous housse de coton et insert en mousse de polyuréthane (densité 25 Kg/mc). Coussin d'assise en mousse de polyuréthane (densité 35 Kg/mc), plumes d'oie et fibre de polyester sous housse de coton.

**Suspension:** Sangles élastiques en polypropylène et mousse.

**Kissenstruktur:** vielschichtiges Massivholz.

**Hauptstruktur:** Holz/Metall

**Hauptstruktur - Feinbearbeitung nach Wahl** Holz: noce canaletto-wengè/Metall: french bronze- gun metal- mattes gold.

**Polsterung:** Rückenkissen aus Gänsedaunen und Polyesterfaser mit Einsatz aus Polyurethanschaum (Dichte 25 kg/mc) mit Baumwolle bezug verkleidet. Sitz aus Polyurethanschaum (Dichte 35 kg/mc), Gänsedaunen und Polyesterfaser mit Baumwolle bezug verkleidet.

**Federung:** Elastische Gurte aus Gummi und Polypropylen.

Cod. Tessuto/fabric/tissu/Stoff: 1  
Cod. Pelle/leather/cuir/Leder: 2

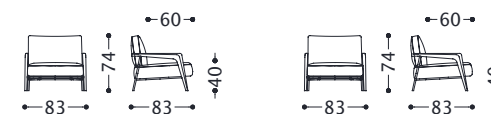

1CECPNC  
2CECPNC

1CECPW  
2CECPW



## JAMMIN poltrona/armchair/fauteuil/Sessel

elementi/elements/éléments/Elemente

designed by Castello Lagravinese Studio



**Struttura portante:** multistrato, massello di legno.

**Imbottiture:** Schienale in poliuretano espanso (densità 21 Kg/mc). Seduta in piuma d'oca con inserto in poliuretano espanso (densità 40 Kg/mc).

**Versione fissa:** piede in metallo (finiture: French Bronze / Gun Metal / Oro Opaco).

**Versione girevole:** basamento girevole in metallo (finiture: French Bronze / Gun Metal / Oro Opaco).

**Main structure:** solid wood.

**Upholstery:** Backrest in polyurethane foam (density 21 Kg/mc). Seat in goose feathers with internal padding in polyurethane foam (density 40 Kg/mc).

**Fix version:** metal feet (finishing options: French Bronze / Gun Metal / Matt Gold).

**Swivel version:** metal base (finishing options: French Bronze / Gun Metal / Matt Gold).

**Structure:** Multiplis et bois massif.

**Rembourrage:** Dossier en mousse de polyuréthane (densité 21 kg/mc). Assise en plume d'oie avec insert en mousse de polyuréthane (densité 40 kg/mc).

**Version fixe:** pied en métal (versions de finitions: French Bronze / Gun Metal / Or Mat).

**Version tournante:** piètement pivotant en métal (versions de finitions: French Bronze / Gun Metal / Or Mat).

**Struktur:** vielschichtiges Massivholz.

**Polsterung:** Rückenlehne aus Polyurethanschaum (Dichte 21 Kg/mc). Sitz aus Gänsedaunen mit Einsatz aus Polyurethanschaum (Dichte 40 Kg/mc).

**Fest-Version:** Fuß aus Metall (Auswahl: French Bronze / Gun Metal / Mattes Gold).

**Dreh-Version:** Drehbasis aus Metall (Auswahl: French Bronze / Gun Metal / Mattes Gold).

Cod. Tessuto/fabric/tissu/Stoff: 1

Cod. Pelle/leather/cuir/Leder: 2

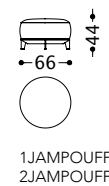
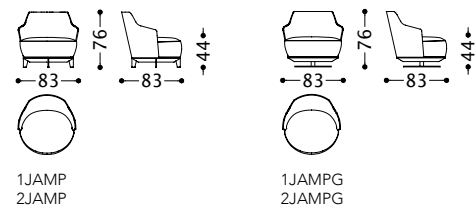

## JAMMIN LARGE poltrona/armchair/fauteuil/Sessel

elementi/elements/éléments/Elemente

designed by Castello Lagravinese Studio



**Struttura portante:** multistrato, massello di legno.

**Imbottiture:** Schienale in poliuretano espanso (densità 21 Kg/mc). Seduta in piuma d'oca con inserto in poliuretano espanso (densità 40 Kg/mc).

**Versione fissa:** piede in metallo (finiture: French Bronze / Gun Metal / Oro Opaco).

**Versione girevole:** basamento girevole in metallo (finiture: French Bronze / Gun Metal / Oro Opaco).

**Main structure:** solid wood.

**Upholstery:** Backrest in polyurethane foam (density 21 Kg/mc). Seat in goose feathers with internal padding in polyurethane foam (density 40 Kg/mc).

**Fix version:** metal feet (finishing options: French Bronze / Gun Metal / Matt Gold).

**Swivel version:** metal base (finishing options: French Bronze / Gun Metal / Matt Gold).

**Structure:** Multiplis et bois massif.

**Rembourrage:** Dossier en mousse de polyuréthane (densité 21 kg/mc). Assise en plume d'oie avec insert en mousse de polyuréthane (densité 40 kg/mc).

**Version fixe:** pied en métal (versions de finitions: French Bronze / Gun Metal / Or Mat).

**Version tournante:** piètement pivotant en métal (versions de finitions: French Bronze / Gun Metal / Or Mat).

**Struktur:** vielschichtiges Massivholz.

**Polsterung:** Rückenlehne aus Polyurethanschaum (Dichte 21 Kg/mc). Sitz aus Gänsedaunen mit Einsatz aus Polyurethanschaum (Dichte 40 Kg/mc).

**Fest-Version:** Fuß aus Metall (Auswahl: French Bronze / Gun Metal / Mattes Gold).

**Dreh-Version:** Drehbasis aus Metall (Auswahl: French Bronze / Gun Metal / Mattes Gold).

Cod. Tessuto/fabric/tissu/Stoff: 1

Cod. Pelle/leather/cuir/Leder: 2

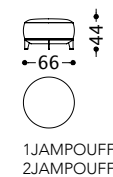
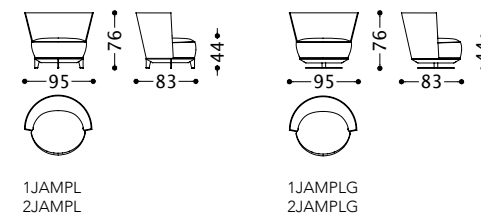



## SENATOR poltrona relax/relax armchair/fauteuil relax/Sessel relax

elementi/elements/éléments/Elemente

designed by Metrica Milano Design



### POLTRONA RELAX

Struttura portante: gabbia metallica.

Imbottiture: poliuretano espanso schiumato a freddo rivestito con resinato.

Meccanica: Schienale reclinabile con comando manuale inserito all'interno del bracciolo. Meccanismo girevole con return memory.

Basamento: 4 razze in metallo finitura cromo nero.

### RELAX ARMCHAIR

Main structure: metal cage.

Upholstery: cold polyurethane foam covered with resinate.

Mechanics: reclining backrest with manual mechanism placed inside the armrest. Swivel mechanism – return memory.

Base: 4 legged metal frame in glossy black chrome

### FAUTEUIL RELAX

Structure de support: cage métallique.

Rembourrage: mousse de polyuréthane à froid.

Mécanique: Dossier réglable, avec commande manuelle disposé à l'intérieur de l'accoudoir. Mécanisme pivotant avec le retour.

Base: 4 branches en metal finition chrome noir.

### SESSEL RELAX

Hauptstruktur: Metallkäfig.

Polsterung: Kaltpolyurethanschaum mit Resinat bedeckt.

Mechanik: verstellbare Rückenlehne, mit manueller Steuerung im Innern der Armlehne eingefügt, Drehmechanismus mit "Return Memory".

Basis: Vierspeiche aus Metall, Feinbearbeitung Chromschwarz.

### POUFF

Struttura portante: multistrato.

Imbottitura: poliuretano espanso.

Basamento: 4 razze in metallo finitura cromo nero.

### POUF

Main structure: solid wood.

Upholstery: polyurethane foam.

Base: 4 legged metal frame in glossy black chrome

### POUF

Structure de support: multiples et bois massif.

Rembourrage: mousse de polyuréthane.

Base: 4 branches en metal finition chrome noir.

### HOCKER

Hauptstruktur: Massivholz.

Polsterung: Polyurethanschaum.

Basis: Vierspeiche aus Metall, Feinbearbeitung Chromschwarz

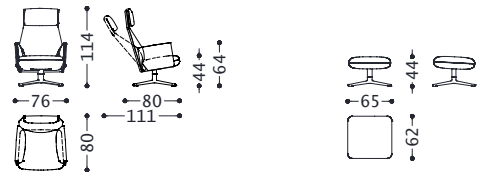

2SENPAG  
2SENPAGSG  
2SENPAGPT

2SENPouFF

## EVOLUTION poltrona relax/relax armchair/fauteuil relax/Sessel relax

elementi/elements/éléments/Elemente

designed by Alberta Style Department



2EVLPAAGNO  
2EVLPOUFFAL



2EVLPAAGRN  
2EVLPOUFFAL

### POLTRONA RELAX

Struttura portante: gabbia metallica

Imbottiture: poliuretano espanso schiumato a freddo rivestito con resinato

Struttura esterna rivestita in multistrato impiallacciato a scelta: noce (Cod. 2EVLPAAGNO/2EVLPAAGNONV) o rovere naturale (Cod. 2EVLPAAGRN)

Meccanica: Schienale reclinabile, poggiatesta regolabile. Meccanismo girevole con return memory

Basamento per poltrona relax noce: 4 razze in alluminio lucido o nero verniciato

Basamento per poltrona relax rovere naturale: 4 razze in alluminio lucido

### RELAX ARMCHAIR

Main structure: metal cage

Upholstery: cold polyurethane foam covered with resinate

Surface covered in veneer-options: walnut (Cod. 2EVLPAAGNO/2EVLPAAGNONV) or natural oak (Cod. 2EVLPAAGRN)

Mechanics: reclining backrest, adjustable headrest. Swivel mechanism – return memory

Base for relax armchair-walnut: 4 legged metal frame in glossy aluminum or varnished black

Base for relax armchair-natural oak: 4 legged metal frame in glossy aluminum

### FAUTEUIL RELAX

Structure de support: cage métallique

Rembourrage: mousse de polyuréthane à froid

Structure extérieure revêtu de placage de contreplaqué à choix: noyer (Cod. 2EVLPAAGNO/2EVLPAAGNONV), ou chêne naturel (Cod. 2EVLPAAGRN)

Mécanique: Dossier réglable, appui-tête réglable. Mécanisme pivotant avec le retour.

Base pour fauteuil relax-noyer: 4 branches en aluminium poli ou noir verni.

Base pour fauteuil relax- chêne naturel: 4 branches en aluminium poli.

### SESSEL RELAX

Hauptstruktur: Metallkäfig.

Polsterung: Kaltpolyurethanschaum mit Resinat bedeckt.

Außenstruktur aus Schichtholz furniert-Auswahl: Nussbaum (Cod. 2EVLPAAGNO/2EVLPAAGNONV) oder Eiche (Cod. 2EVLPAAGRN).

Mechanik: verstellbare Rückenlehne, verstellbare Kopfstütze. Drehmechanismus mit "Return Memory".

Basis für Sessel relax -Nussbaum: vierspeiche aus glänzendem Aluminium oder Schwarz lackiert.

Basis für Sessel relax -Eiche: vierspeiche aus glänzendem Aluminium.

### POUFF

Struttura portante: multistrato.

Imbottitura: poliuretano espanso.

Basamento: 4 razze in alluminio lucido (Cod. 2EVLPOUFFAL) o nero verniciato (Cod. 2EVLPOUFFNV).

### POUF

Main structure: solid wood.

Upholstery: polyurethane foam.

Base: 4 legged metal frame in glossy aluminum (Cod. 2EVLPOUFFAL) or varnished black (Cod. 2EVLPOUFFNV).

### POUF

Structure de support: multiples et bois massif.

Rembourrage: mousse de polyuréthane.

Base: 4 branches en aluminium poli (Cod. 2EVLPOUFFAL) ou noir verni (Cod. 2EVLPOUFFNV).

### HOCKER

Hauptstruktur: Massivholz.

Polsterung: Polyurethanschaum.

Basis: vierspeiche aus glänzendem Aluminium (Cod. 2EVLPOUFFAL) oder Schwarz lackiert (Cod. 2EVLPOUFFNV).

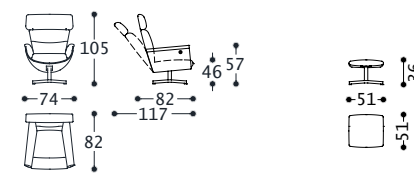

2EVLPAAGNO  
2EVLPAAGNONV  
2EVLPAAGRN

2EVLPOUFFAL  
2EVLPOUFFNV



**MALAY** mobili/furniture/meubles/Möbel  
elementi/elements/éléments/Elemente

designed by Castello Lagravinese Studio



**Top e frontali:** legno impiallacciato con parti in laccato lucido.  
**Struttura e maniglie:** metallo.

**Top and front parts:** veneer wood with lacquered parts.  
**Structure and handles:** Metal.

**Plateau et frontals:** Bois plaque avec des parties laquées.  
**Structure et poignée:** Métal.

**Top und stirnseiten:** Furnierholz mit lackiertes band.  
**Struktur und griffe:** Metall.

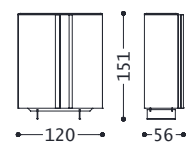

1MAYMADALTA

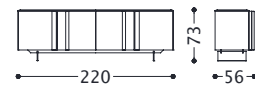

1MAYMADBASSA

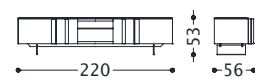

1MAYMOBTV

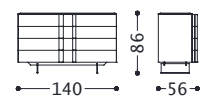

1MAYDRW

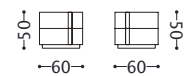

01MAYC1

**ALBERT 1** tavolino/small table/table/Couchtisch  
elementi/elements/éléments/Elemente

designed by Castello Lagravinese Studio



**Struttura:** Legno massello in noce canaletto o rovere scuro.  
**Top:** Marmo

**Structure:** Solid wood in canaletto walnut or dark oak.  
**Top:** Marble

**Structure:** Bois massif en noyer canaletto ou chêne foncé.  
**Plateau:** Marbre

**Struktur:** Massivholz, Nußbaum „Canaletto“ oder Dunkeleiche.  
**Top:** Marmor

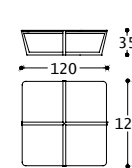

1AL1TAVQ

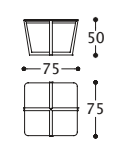

1AL1TAVQ75

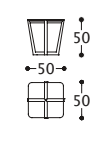

1AL1TAVQ50

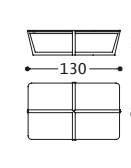

1AL1TAVR

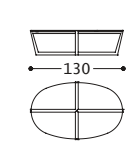

1AL1TAVOV

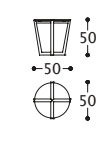

1AL1TROT50



**JAGGER** tavolino/small table/table/Couchtisch  
 elementi/elements/éléments/Elemente

designed by Castello Lagravinese Studio



**Struttura:** metallica a 5 gambe.  
**Finitura struttura:** laccato.  
**Top:** MDF.  
**Finitura top:** laccato.

**Structure:** in metal with 5 legs.  
**Structure finishing:** lacquered.  
**Top:** MDF.  
**Top finishing:** lacquered.

**Structure:** en métal avec 5 jambes.  
**Finition de la structure:** laqué.  
**Plateau:** MDF.  
**Finition du plateau:** laqué.

**Struktur:** aus Metall mit 5 Beine.  
**Strukturbearbeitung:** lackiert.  
**Top:** MDF.  
**Topbearbeitung:** lackiert.



1JAGTH



1JAGTL



1JAGTM

**JIMMY 3** tavolino/small table/table/Couchtisch  
 elementi/elements/éléments/Elemente

designed by Castello Lagravinese Studio



**Struttura:** metallica.  
**Finitura struttura:** French bronze / Gun Metal / Oro Opaco.  
**Top:** MDF (laccato).

**Structure:** in metal.  
**Structure finishing:** French bronze / Gun Metal / Matt Gold.  
**Top:** MDF (lacquered).

**Structure:** en métal.  
**Finition de la structure:** French Bronze / Gun Metal / Or Mat.  
**Plateau:** MDF (laqué).

**Struktur:** aus Metall.  
**Strukturbearbeitung:** French Bronze / Gun Metal / Mattes Gold.  
**Niedriger:** MDF (lackiert).

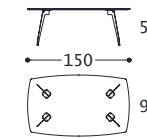

1J13TAVRH

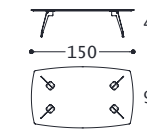

1J13TAVRM

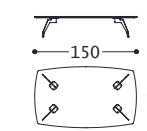

1J13TAVRL

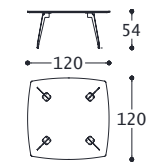

1J13TAVQ120H

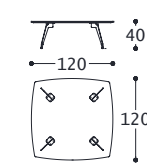

1J13TAVQ120M

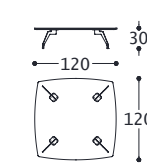

1J13TAVQ120L

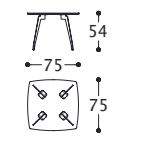

1J13TAVQ75H

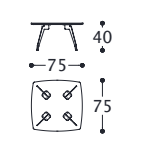

1J13TAVQ75M

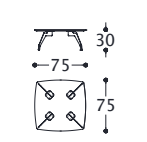

1J13TAVQ75L

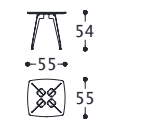

1J13TAVQ55H

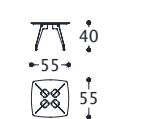

1J13TAVQ55M

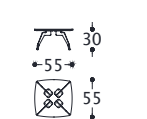

1J13TAVQ55L

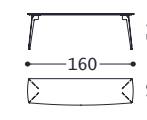

1J13CO160

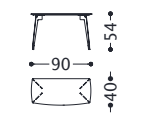

1J13CO90

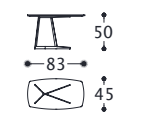

1J13SER



**ISLAND** tavolino/small table/table/Couchtisch  
elementi/elements/éléments/Elemente

designed by Castello Lagravinese Studio



**Struttura:** Metallo.  
**Finitura Struttura:** French bronze / Gun Metal / Oro Opaco.  
**Top:** MDF impiallacciato in Legno Noce Canaletto o Rovere scuro.

**Structure:** Metal.  
**Structure finishing:** French bronze / Gun Metal / Matt Gold.  
**Top:** Canaletto walnut or dark oak veneer MDF.

**Structure:** Métal.  
**Finition de la structure:** French Bronze / Gun Metal / Or Mat.  
**Plateau:** MDF placage en noyer canaletto ou chêne foncé.

**Struktur:** Metall.  
**Strukturbearbeitung:** French Bronze / Gun Metal / Mattes Gold.  
**Top:** MDF, Nußbaumholz „Canaletto“ oder Dunkeleiche furniert.

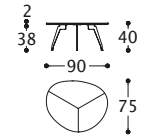

1ISNTSTS40

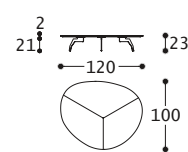

1ISNTMTS23

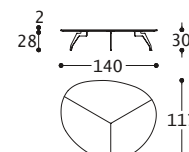

1ISNTLTS30

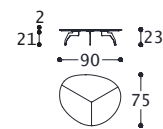

1ISNTST23

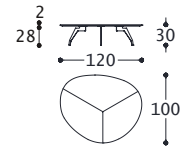

1ISNTMT30

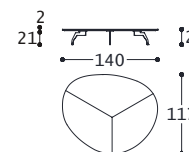

1ISNTLT23

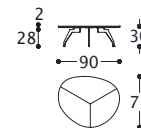

1ISNTST30

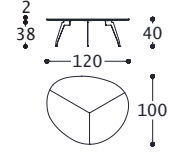

1ISNTMT40

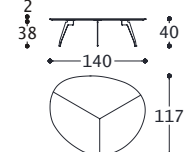

1ISNTLT40

**FRISCO** tavolino/small table/table/Couchtisch  
elementi/elements/éléments/Elemente

designed by Castello Lagravinese Studio



**Struttura:** metallica.  
**Finitura struttura:** French bronze / Gun Metal / Oro Opaco.  
**Top alto (1):** marmo o MDF (laccato).  
**Top basso (2):** MDF (laccato).

**Structure:** in métal.  
**Structure finishing:** French bronze / Gun Metal / Matt Gold.  
**Top high (1):** marble or MDF (lacquered).  
**Top low (2):** MDF (lacquered).

**Structure:** en métal.  
**Finition de la structure:** French Bronze / Gun Metal / Or Mat.  
**Plateau haut (1):** marbre ou MDF (laqué).  
**Plateau bas (2):** MDF (laqué).

**Struktur:** aus Metall.  
**Strukturbearbeitung:** French Bronze / Gun Metal / Mattes Gold.  
**Hoher Top (1):** Marmor oder MDF (lackiert).  
**Niedriger Top (2):** MDF (lackiert).



1FRITROT  
1FRITROT L



1FRITAVQA  
1FRITAVQAL

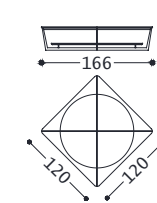

1FRITAVQB  
1FRITAVQBL

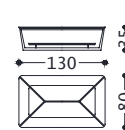

1FRITAVR  
1FRITAVRL



**PHIL** tavolino/small table/table/Couchtisch  
elementi/elements/éléments/Elemente

designed by Castello Lagravinese Studio



**Struttura:** metallica.  
**Finitura struttura:** French bronze / Gun Metal / Oro Opaco.  
**Top:** in marmo o MDF (laccato).

**Structure:** in metal.  
**Structure finishing:** French bronze / Gun Metal / Matt Gold.  
**Top:** marble or MDF (laquered).

**Structure:** en métal.  
**Finition de la structure:** French Bronze / Gun Metal / Or Mat.  
**Plateau:** marbre ou MDF (laqué).

**Struktur:** aus Metall.  
**Strukturbearbeitung:** French Bronze / Gun Metal / Mattes Gold.  
**Top:** Marmor oder MDF (lackiert).

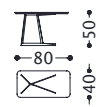

1PHISER  
1PHISERL





Product Development  
Castello Lagravinese Studio  
Studio Memo Firenze: for Cecile model  
Metrica Milano Design: for Senator model



Graphic Assistant  
Bplus marketing  
Color Separation  
GM Studio 1  
Print  
Grafiche Antiga

**alberta**

via Toniolo 41  
31028 Vazzola (TV) - ITALY  
T +39 0438 440440  
F +39 0438 441555  
[www.alberta.it](http://www.alberta.it)



**alberta**

via Toniolo 41, 31028 Vazzola (TV) - ITALY  
[www.alberta.it](http://www.alberta.it)